

- Serrature da infilare
- Serrature per persiane e grate
- Serrature per serrande
- Serrature da applicare
- Serrature per casseforti
- Serrature per porte blindate
- Cuori per serrature
- Piastrine
- Automazione D-SMART
- Cilindri
- Protector e coordinati



SERRATURE DA INFILARE

SERRATURE A DOPPIA MAPPA

Serrature a doppia mappa di altissima sicurezza per serramenti e cancelletti, chiusure laterali e triplici. Dotate di brevetti contro la manipolazione.

SERRATURE A CILINDRO EUROPEO

Serrature a cilindro per serramenti e cancelletti. Catenaccio a 3 pistoni Ø 14 e catenaccio a 4 pistoni Ø 12, entrata 60 mm. Predisposizione al protector interasse 38 mm.

MANO

X= solo catenaccio senza scrocco
U= universale con scrocco reversibile

FINITURA FRONTALE

ZB= zincata bianca
OT= ottonata
CR= cromata
Al= acciaio inox

TIPO DI SERRATURA

A= doppia mappa 6 leve
XX= cilindro



MODELLO CHIAVE

B= OCVBXNISBOZ } B= 68 mm
C= OCVCXNISBOZ } C= 78 mm
6= OCV6XNISBOZ } SECURMAP 11 6= 93 mm
3= OCV3XNISBOZ } SECURMAP 16 3= 68 mm
8= OCV8XNISBOZ } 8= 98 mm



2001 - DOPPIA MAPPA

• Dotazione: 1 contropiastra CP2001XZB e 2 piastrine 4901XZB

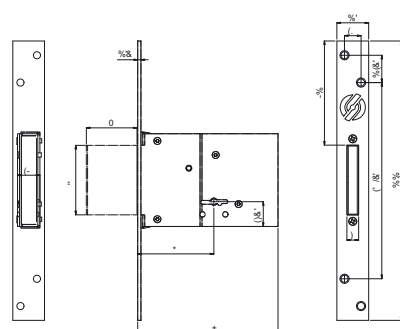

ART.	Entrata	Lunghezza	Chiusure	Mandate	Corsa (A)	Corsa (B)
2001XZB50XXAB2	50	80	1	2	20	-
2001XZB60XXA33	60	112	1	4	40	-
2001XZB70XXA33	70	122	1	4	40	-

SECURMAP 11

2003 - DOPPIA MAPPA

• Dotazione: 1 contropiastra CP2001XZB e 2 piastrine 4901XZB

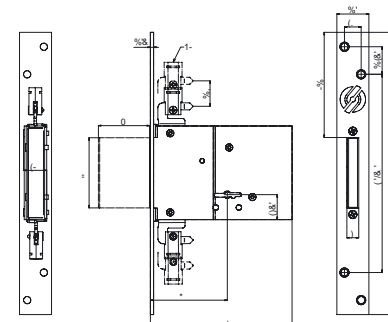

ART.	Entrata	Lunghezza	Chiusure	Mandate	Corsa (A)	Corsa (B)
2003XZB50XXAB2	50	80	3	2	20	20
2003XZB60XXA33	60	112	3	4	40	20
2003XZB70XXA33	70	122	3	4	40	20

SECURMAP 11

2013 - DOPPIA MAPPA

• Dotazione: 1 contropiastra CP2001XZB e 2 piastrine 4901XZB

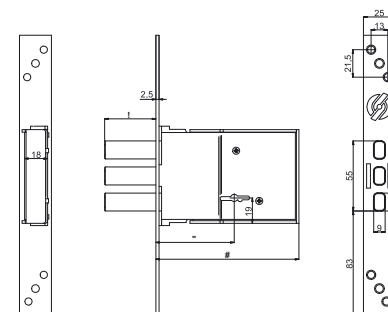

ART.	Entrata	Lunghezza	Chiusure	Mandate	Corsa (A)	Corsa (B)
2011XZB50XXAB2	50	80	1	2	20	-
2011XZB60XXAB2	60	112	1	4	40	-
2011XZB70XXAB2	70	122	1	4	40	-

2013 - DOPPIA MAPPA

• Dotazione: 1 contropiastra CP2001XZB e 2 piastrine 4901XZB

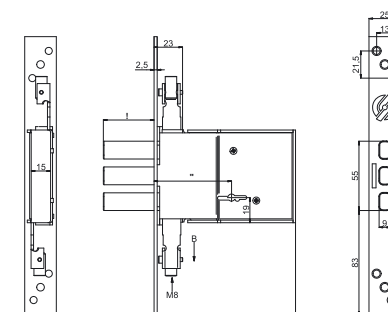

ART.	Entrata	Lunghezza	Chiusure	Mandate	Corsa (A)	Corsa (B)
2013XZB50XXAB2	50	80	3	2	20	18
2013XZB60XXAB2	60	112	3	4	40	18
2013XZB70XXAB2	70	122	3	4	40	18

2008 - DOPPIA MAPPA

• Dotazione: 2 piastrine 4901XZB

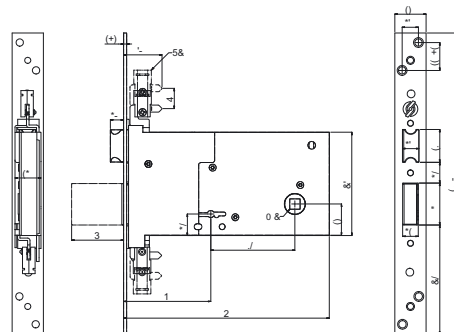

ART.	Entrata	Lunghezza	Chiusure	Mandate	Corsa (A)	Corsa (B)
2008UZB70XXAB3	70	164	3	4	40	16
2008UZB90XXAB3	90	184	3	4	40	16

2010 - DOPPIA MAPPA

• Dotazione: 2 piastrine 4901XZB

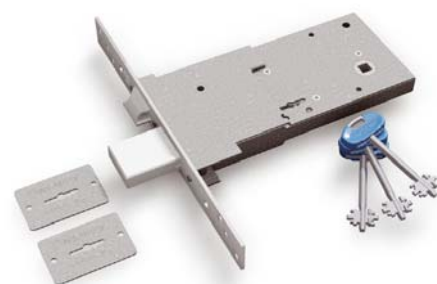
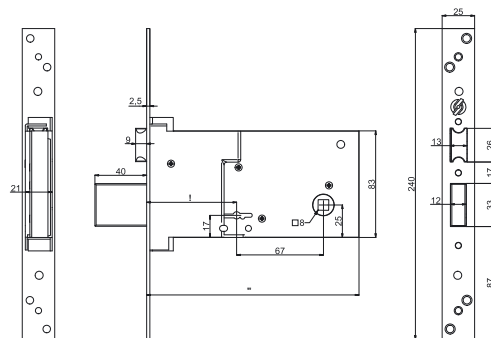

2000 - DOPPIA MAPPA

• Dotazione: 1 contropiastra CP2000XZB e 2 piastrine 4921KF1

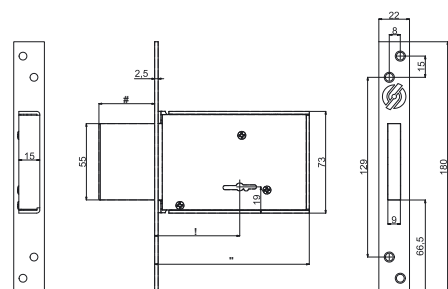

ART.	Entrata	Lunghezza	Chiusure	Mandate	Corsa (A)	Corsa (B)
2000XZB40XXAB3	40	73	1	2	20	-
2000XZB50XXAB3	50	102	1	4	40	-
2000XZB60XXAB3	60	112	1	4	40	-
2000XZB70XXAB3	70	122	1	4	40	-

2020 - DOPPIA MAPPA

• Dotazione: 1 contropiastra CP2020XOT/CP2020XCR e 2 piastrine 4921KF3/4921KF1

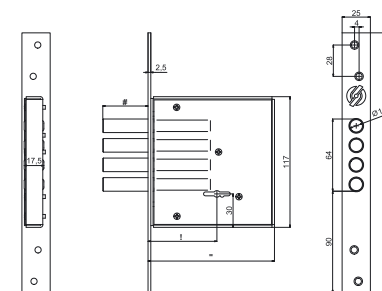

SECURMAP 11

ART.	Entrata	Lung.	Chiusure	Mandate	Corsa (A)	Corsa (B)
2020XOT60XXA33	60	112	1	4	40	-
2020XOT60XXA35	60	112	1	4	40	-
2020XCR60XXA33	60	112	1	4	40	-
2020XCR60XXA35	60	112	1	4	40	-

ART.	Entrata	Lung.	Chiusure	Mandate	Corsa (A)	Corsa (B)
2020XOT60XXA63	60	112	1	4	40	-
2020XOT60XXA65	60	112	1	4	40	-
2020XCR60XXA63	60	112	1	4	40	-
2020XCR60XXA65	60	112	1	4	40	-

2024 - DOPPIA MAPPA

• Dotazione: 1 contropiastra CP2024XOT/CP2024XCR e 2 piastrine 4921KF3/4921KF1

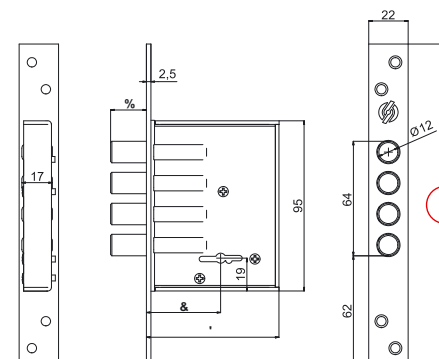

ART.	Entrata	Lunghezza	Chiusure	Mandate	Corsa (A)	Corsa (B)
2024XOT40XXAB3	40	75	1	2	20	-
2024XOT40XXAB5	40	75	1	2	20	-
2024XCR40XXAB3	40	75	1	2	20	-
2024XCR40XXAB5	40	75	1	2	20	-

2025 - DOPPIA MAPPA

• Dotazione: 1 contropiastra CP2024XOT/CP2024XCR e 2 piastrine 4921KF3/4921KF1

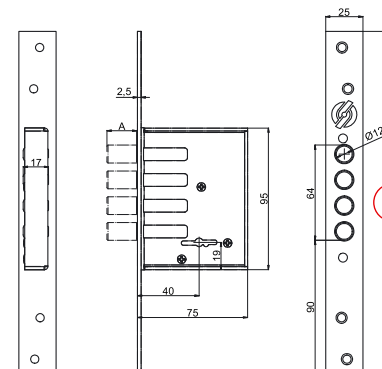

SECURMAP 11

ART.	Entrata	Lunghezza	Chiusure	Mandate	Corsa (A)	Corsa (B)
2025XOT40XXA33	40	75	1	2	20	-
2025XOT40XXA35	40	75	1	2	20	-
2025XCR40XXA33	40	75	1	2	20	-
2025XCR40XXA35	40	75	1	2	20	-

2028 - DOPPIA MAPPA

- Dotazione: 1 contropiastra CP2024XOT/CP2024XCR e 2 piastrine 4921KF3/4921KF1

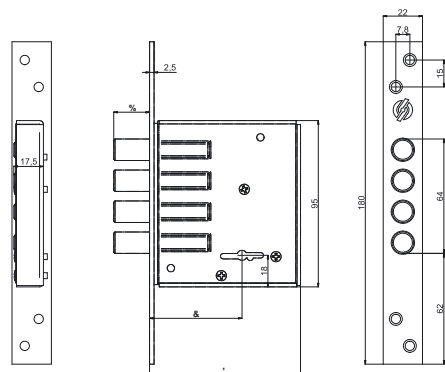

SECURMAP 11

ART.	Entrata	Lunghezza	Chiusure	Mandate	Corsa (A)	Corsa (B)
2028XOT50XXA33	50	84	1	2	20	-
2028XOT50XXA35	50	84	1	2	20	-
2028XCR50XXA33	50	84	1	2	20	-
2028XCR50XXA35	50	84	1	2	20	-

2018 - DOPPIA MAPPA

- Dotazione: 1 contropiastra CP2017XOT/CP2017XZB e 2 piastrine 4921KF3/4921KF1

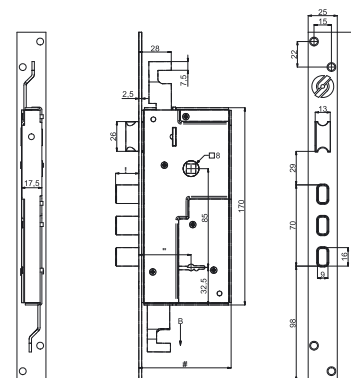

ART.	Entrata	Lunghezza	Chiusure	Mandate	Corsa (A)	Corsa (B)
2018UOT45XXAB3	45	80	3	2	20	-
2018UOT45XXAB5	45	80	3	2	20	-
2018UZB45XXAB3	45	80	3	2	20	-
2018UZB45XXAB5	45	80	3	2	20	-

2029 - DOPPIA MAPPA

- Dotazione: 1 contropiastra CP2024XOT/CP2024XCR e 2 piastrine 4921KF3/4921KF1

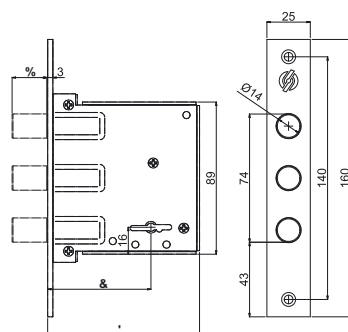

SECURMAP 11

ART.	Entrata	Lunghezza	Chiusure	Mandate	Corsa (A)	Corsa (B)
2029XCR60XXA65	60	88	1	2	20	-

2021 - DOPPIA MAPPA

- Dotazione: 1 contropiastra CP2017XOT/CP2017XZB e 2 piastrine 4921KF3/4921KF1

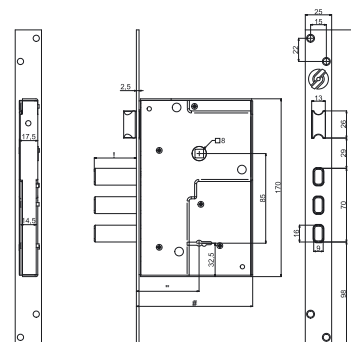

ART.	Entrata	Lunghezza	Chiusure	Mandate	Corsa (A)	Corsa (B)
2021UOT60XXAB5	60	112	1	4	40	-
2021UZB60XXAB5	60	112	1	4	40	-

2017 - DOPPIA MAPPA

- Dotazione: 1 contropiastra CP2017XOT/CP2017XZB e 2 piastrine 4921KF3/4921KF1

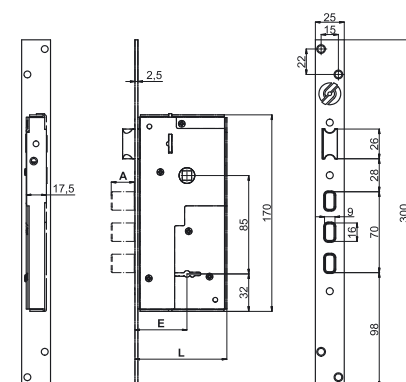

ART.	Entrata	Lunghezza	Chiusure	Mandate	Corsa (A)	Corsa (B)
2017UOT45XXAB3	45	80	1	2	20	-
2017UOT45XXAB5	45	80	1	2	20	-
2017UZB45XXAB3	45	80	1	2	20	-
2017UZB45XXAB5	45	80	1	2	20	-

2022 - DOPPIA MAPPA

- Dotazione: 1 contropiastra CP2017XOT/CP2017XZB e 2 piastrine 4921KF3/4921KF1

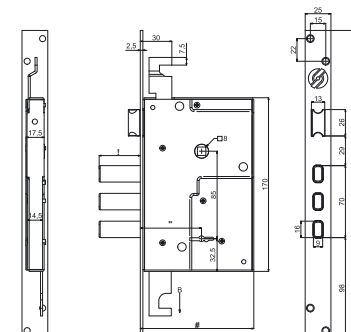

ART.	Entrata	Lunghezza	Chiusure	Mandate	Corsa (A)	Corsa (B)
2022UOT60XXAB5	60	112	3	4	40	16
2022UZB60XXAB5	60	112	3	4	40	16

2019 - DOPPIA MAPPA

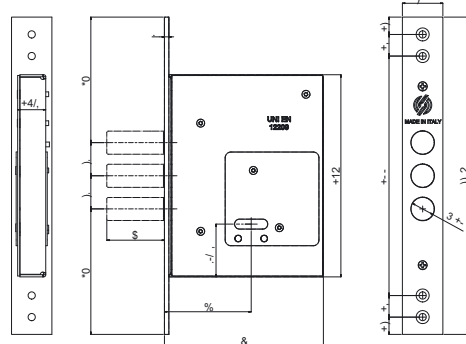

ART.	Entrata	Lunghezza	Chiusure	Mandate	Corsa (A)	Corsa (B)
2019XCR60XXA85	60	110	1	4	40	-

2061 - CILINDRO EUROPEO

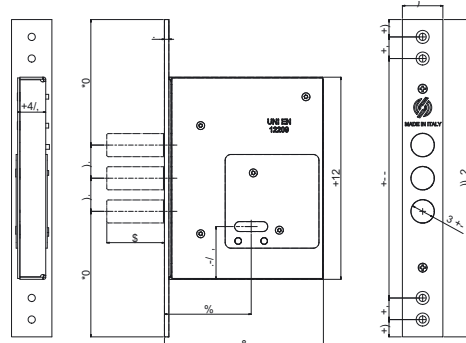

ART.	Entrata	Lunghezza	Chiusure	Mandate	Corsa (A)	Corsa (B)
2061UCR60XX	60	110	1	3	34	-

2071 - CILINDRO EUROPEO

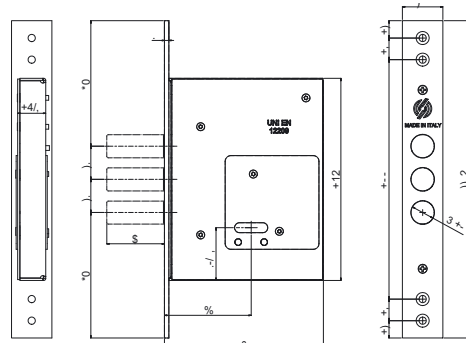

ART.	Entrata	Lunghezza	Chiusure	Mandate	Corsa (A)	Corsa (B)
2071UAI60XX	60	87	1	2	20	-

2051 - CILINDRO EUROPEO

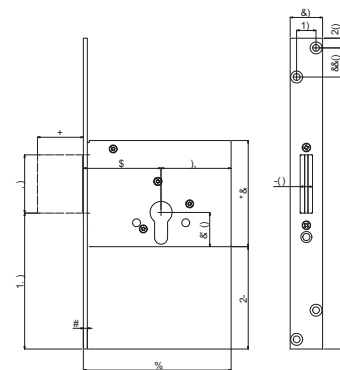

ART.	Entrata	Lunghezza	Chiusure	Mandate	Corsa (A)	Corsa (B)
2051XZB60XX	60	114	1	3	30	-
2051XZB70XX	70	124	1	3	30	-

2053 - CILINDRO EUROPEO

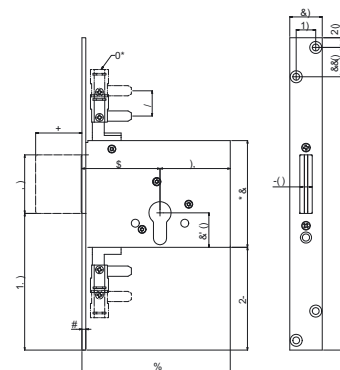

ART.	Entrata	Lunghezza	Chiusure	Mandate	Corsa (A)	Corsa (B)
2053XZB60XX	60	114	3	3	30	20
2053XZB70XX	70	124	3	3	30	20

ACCESSORI

5803

- Asta filettata con attacco $\varnothing 8$ $\varnothing 10 \times 1200$ mm completa di puntale carbonitrurato antitaglio $\varnothing 10$ mm

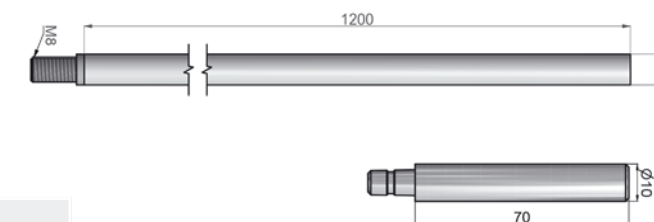

ART.	Per serie/art.
5803XZB1008	2003, 2008, 2013

5818

- Asta $\varnothing 8$ $\varnothing 10 \times 1200$ mm con attacco a gancio completa di puntale carbonitrurato antitaglio $\varnothing 10$ mm

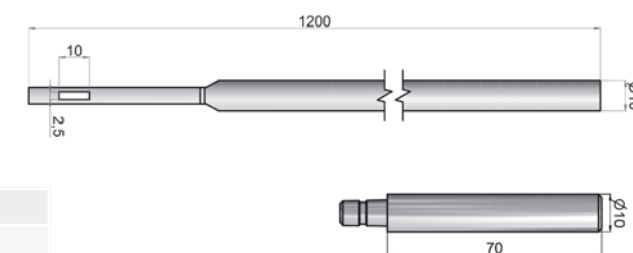

ART.	Per serie/art.
5818XZB10GN	2018, 2022

ACCESSORI

4921K..

- Piastrine interne ed esterne 45x65 mm per chiave a doppia mappa con foro chiave serratura



ART.	Finiture
4921K..	CL - OL - F1 - F3 - F4

4922K..

- Piastrine interne ed esterne in alluminio 45x65 mm per chiave a cilindro



ART.	Finiture
4922K..	CL - OL - F1 - F3 - F4

4901X ZB

- Piastrina 55x37 mm per chiave a doppia mappa



ART.	Finitura
4901XZB	ZB

CP2001X ZB

- Contropiastra 22x180x2,5 mm per serrature ad infilare art. 2001

ART.	Finitura
CP2001XZB	ZB

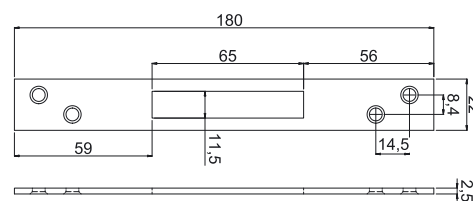

CP2008X ZB

- Contropiastra 25x150x2,5 mm per serrature ad infilare art. 2008, 2010

ART.	Finitura
CP2001XZB	ZB

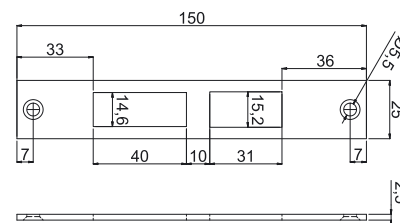

5220XBK4050

- Maniglia per serramenti in nylon nera con viti in testa

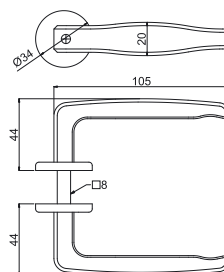

ART.	Finitura
5220XBK4050	BK

SERRATURE PER PERSIANE E GRATE

SERRATURE TIGHT A DOPPIA MAPPA

Serrature TIGHT a doppia mappa per persiane che rispondono alla duplice esigenza di contenere lo spazio e aumentare la sicurezza. **Funzionamento del catenaccio a gancio comandato da maniglia.** Blocco della maniglia tramite chiave a doppia mappa con 2 mandate. Serrature laterali con catenaccio, duplici con solo aste, triplici con catenaccio e aste. Entrata 25, 30, 35 mm.

MANO

X= Reversibile

FINITURA FRONTALE

ZB= zincata bianca
Al= acciaio inox

MODELLO CHIAVE

B= OCVBXNISBOZ



TIPO DI SERRATURA

A= doppia mappa 6 leve

B= 68 mm



Possibilita di esecuzione di gruppi con stessa combinazione (KA). Per comporre il codice aggiungere alla fine KA. Es. 2101XZB2525AB2KA

2101 DOPPIA MAPPA

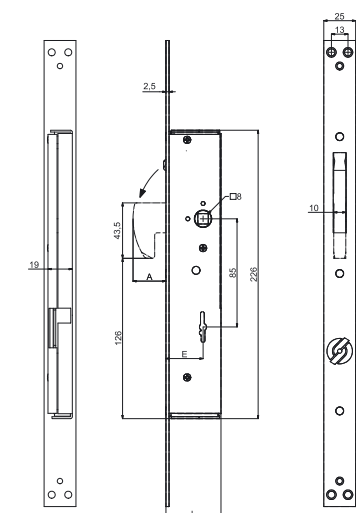

ART.	Entrata	Lunghezza	Chiusure	Mandate	Corsa (A)	Corsa (B)
2101XZB2525AB2	25	39	1	2	25	-
2101XZB3025AB2	30	44	1	2	25	-
2101XZB3525AB2	35	49	1	2	25	-

2102 DOPPIA MAPPA

- Finitura zincato bianco

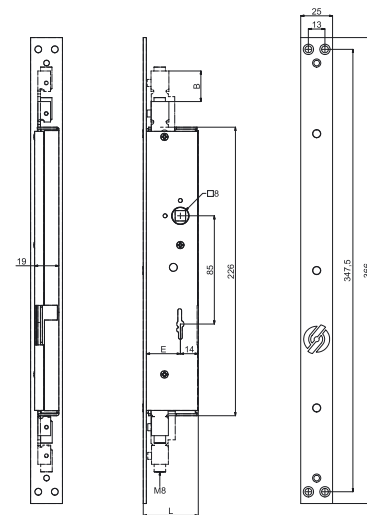

ART.	Entrata	Lunghezza	Chiusure	Mandate	Corsa (A)	Corsa (B)
2102XZB2525AB2	25	39	2	2	-	24
2102XZB3025AB2	30	44	2	2	-	24
2102XZB3525AB2	35	49	2	2	-	24

2103 DOPPIA MAPPA

- Finitura zincato bianco
- Attacco aste M8

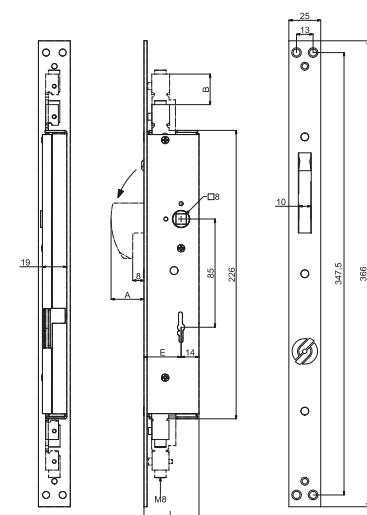

ART.	Entrata	Lunghezza	Chiusure	Mandate	Corsa (A)	Corsa (B)
2103XZB2525AB2	25	39	3	2	25	24
2103XZB3025AB2	30	44	3	2	25	24
2103XZB3525AB2	35	49	3	2	25	24

4911

- Placca 24x154 mm copriforo maniglia e chiave in acciaio

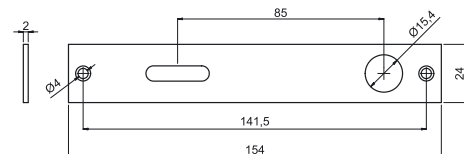

ART.	Finitura
4911XBK	BK

SERRATURE PER SERRANDE E GARAGE

SERRATURE A DOPPIA MAPPA

Serrature con chiave a doppia mappa per serrande e garage. In versione centrale, destra, sinistra, coppia destra e sinistra con stessa cifratura (KA), con catenaccio dritto o zancato. Intercambiabile con quelle presenti in commercio. Disponibili in versione Securmap 11 con brevetti contro la manipolazione e chiave a duplicazione protetta.

MANO

- X= centrale
- S= sinistra
- D= destra

TIPO DI SERRATURA

- A= doppia mappa 6 leve
- XX= cilindro

SPORGENZA ASTE

- 20 - 45 - 70

MODELLO CHIAVE

- B= OCVBXNISBOZ
- 3= OCV3XNISBOZ

H. GUIDACHIAVE

- 08= h 8 mm
- Guidachiave componibile (Art. GC2200XZBXX08)



3=B= 68 mm

FINITURA FRONTALE

- ZB= zincata bianca

Possibilita di esecuzione di gruppi con stessa combinazione (KA). Per comporre il codice aggiungere alla fine KA. Es. 2200XZB4508AB2KA



2200 - DOPPIA MAPPA

- Serratura centrale

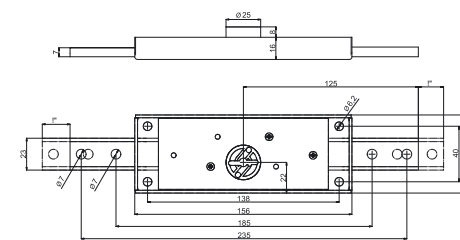

ART.	Mano	Chiusure	Mandate	Catenaccio	Finitura
2200XZB4508A32	X	2	2	Dritto	ZB
2205XZB4508A32	X	2	2	Zancato	ZB

SECURMAP 11

VEDI TUTTE LE SERRATURE E GLI ACCESSORI SECUREMME NELLA SEZIONE DEDICATA: SERRATURE PER SERRANDE

SERRATURE DA APPLICARE

SERRATURE A DOPPIA MAPPA

Serrature di sicurezza da applicare a doppia mappa.
Catenaccio in acciaio cromato 10x60 mm. 6 mandate, corsa 72 mm.

MANO S= sinistra D= destra	MODELLO CHIAVE F= OCAFXNISBOZ (F= 110 mm)	CHIAVI 3 Chiavi. Entrata 50 mm
TIPO DI SERRATURA A= doppia mappa 6 leve	FINITURA FRONTALE MA= marrone	MODELLO Ferroglietto 2304 - Spranga 2306

2304 - DOPPIA MAPPA

- 1 piastrina 4921KF3
- 1 contropiastra CP2304XMAXXXX
- Catenaccio movimentato da chiave

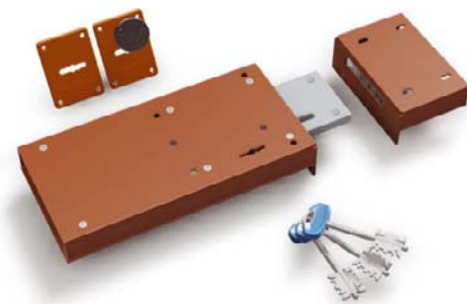
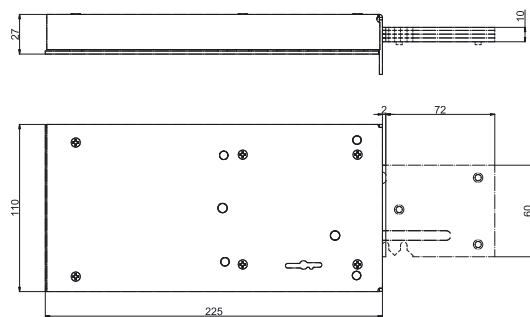

ART.	Entrata	Chiusure	Mandate	Corsa	Finitura
2304DMA50XXAF3	50	1	6	72	MA
2304SMA50XXAF3	50	1	6	72	MA

2306 - DOPPIA MAPPA

- 1 piastrina 4921KF3
- 1 contropiastra CP2304XMAXXXX
- Catenaccio movimentato da chiave

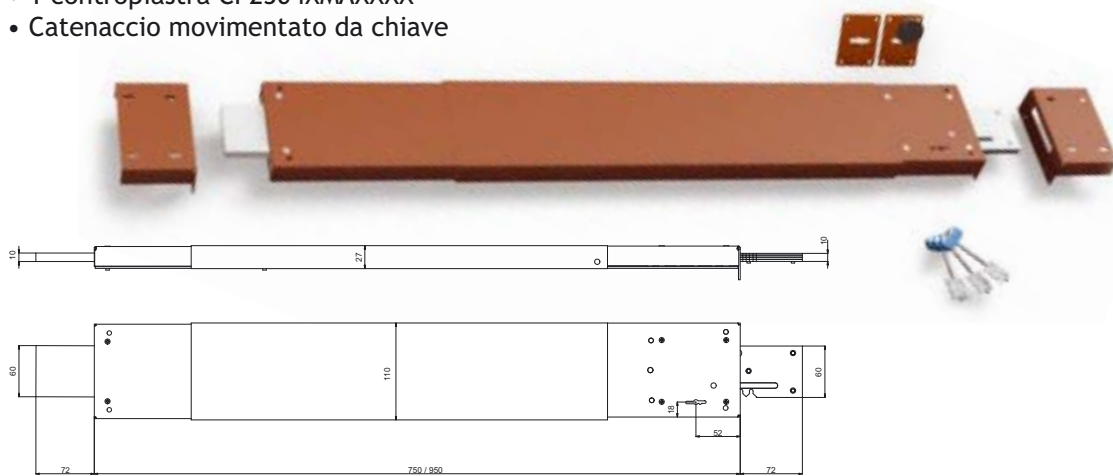

ART.	Entrata	Chiusure	Mandate	Corsa	Finitura
2306DMA50XXAF3	50	2	6	72	MA
2306SMA50XXAF3	50	2	6	72	MA

SERRATURE PER CASSEFORTI

CASSETTE DI SICUREZZA E ARMADI PORTA FUCILI

Serrature laterali a doppia mappa a 6 leve per cassette di sicurezza e armadi porta fucili. Versione con pistoni Ø 10 mm o versione con catenaccio.

MANO S = sinistra D = destra	USCITA CHIAVE/ N. POMELLI 01 = uscita chiave solo sulla 2° mandata 02 = uscita chiave a 0 e sulla 2° mandata 03 = 3	TIPO DI SERRATURA B = cassaforte 6 gorges F = cassaforte 8 gorges
TIPO DI SERRATURA A = doppia mappa 6 leve	GUIDACHIAVE GC = con guidachieve XX = senza guidachieve	MODELLO CHIAVE C = OCVCXNISBOZ 8 = OCF8XNISBOZ 2 Chiavi
FINITURA ZB = zincata bianca GR = grigia RO = rossa		



UNI ENV 1300 RAPPORTO DI PROVA N. 167751 - DELL'ISTITUTO GIORDANO
Le serrature di altissima sicurezza per cassaforti a 8 leve "serie 2800" sono state testate in base alla norma UNI ENV 1300 del febbraio 1999 secondo il rapporto di prova N. 167751 dell'Istituto Giordano e risultano soddisfare la classe A.

2311S GC - PER CASSETTE DI SICUREZZA

- Serratura laterale con catenaccio a 3 pistoni e guidachieve

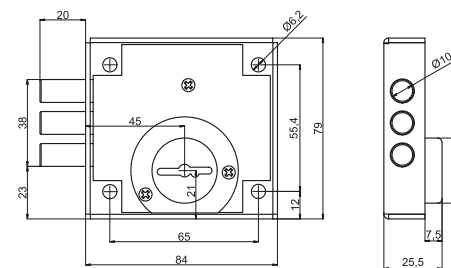

ART.	Gorges	Chiusure	Corsa	Uscita Chiave	Finitura
2311SZB01GCBC2	6	1	20	01	ZB
2311SZB02GCBC2	6	1	20	02	ZB

2311S XX - PER CASSETTE DI SICUREZZA

- Serratura laterale con catenaccio a 3 pistoni

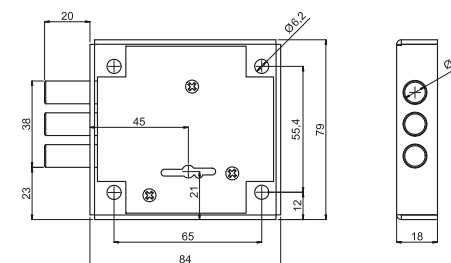

ART.	Gorges	Chiusure	Corsa	Uscita Chiave	Finitura
2311SZB01XXBC2	6	1	20	01	ZB
2311SZB02XXBC2	6	1	20	02	ZB

2313D XX - PER CASSETTE DI SICUREZZA

- Serratura laterale destra

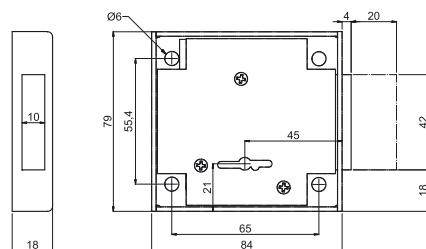

ART.	Gorges	Chiusure	Corsa	Uscita Chiave	Finitura
2313DZB02XXBC2	6	1	20	02	ZB

2313S XX - PER CASSETTE DI SICUREZZA

- Serratura laterale sinistra

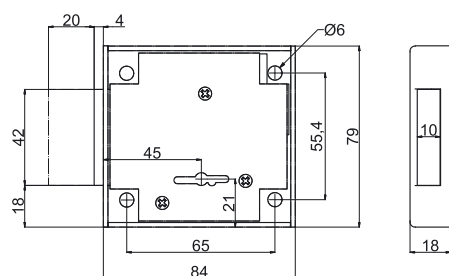

ART.	Gorges	Chiusure	Corsa	Uscita Chiave	Finitura
2313SZB02XXBC2	6	1	20	02	ZB

2380S GC - PER CASSETTE DI SICUREZZA

- Serratura laterale di traino

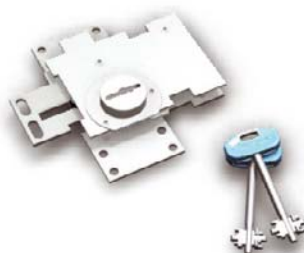
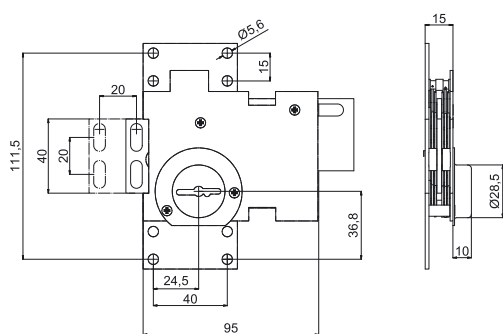

ART.	Gorges	Chiusure	Corsa	Uscita Chiave	Finitura
2380SZB01GCBC2	6	1	20	01	ZB

2381S GC - PER CASSETTE DI SICUREZZA

- Serratura laterale di traino con catenaccio predisposto per 3 pistoni girevoli

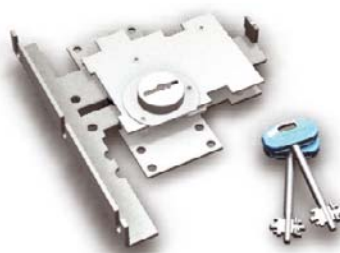
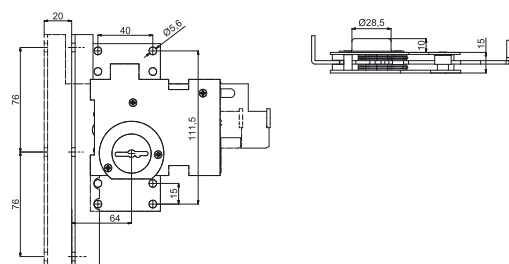

ART.	Gorges	Chiusure	Corsa	Chiave	Finitura
2381SZB01GCBC2	6	1	20	01	ZB

2382S XX - PER CASSETTE DI SICUREZZA

- Serratura laterale di traino

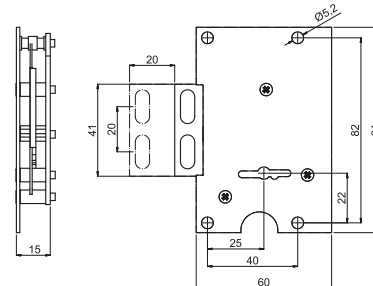

ART.	Gorges	Chiusure	Corsa	Uscita Chiave	Finitura
2382SZT01XXBC2	6	1	20	01	ZB

2390S GC - PER CASSETTE DI SICUREZZA

- Serratura triplice di traino

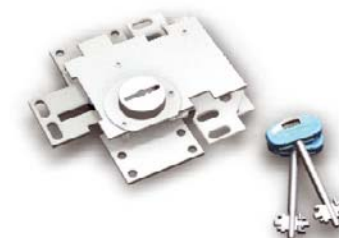
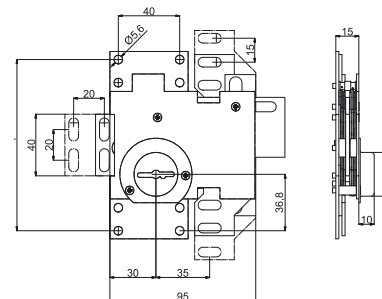

ART.	Gorges	Chiusure	Corsa	Uscita Chiave	Finitura
2390SZB01GCBC2	6	3	20	01	ZB

2391S GC - PER CASSETTE DI SICUREZZA

- Serratura triplice di traino con catenaccio predisposto per 3 pistoni girevoli

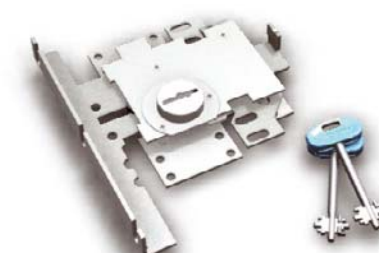
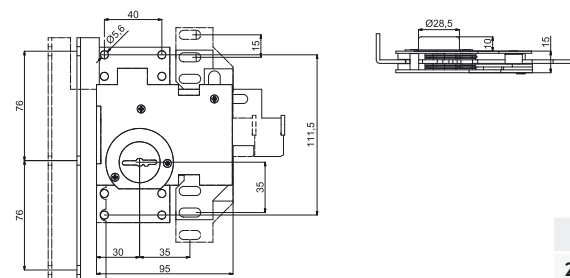

ART.	Gorges	Chiusure	Corsa	Uscita Chiave	Finitura
2391SZB01GCBC2	6	3	20	01	ZB

7011X - PER CASSETTE DI SICUREZZA

- Piastra di fissaggio 83,5x79x2 mm per art. 2311, 2313

ART.	Finitura
7011XZB20M5	ZB

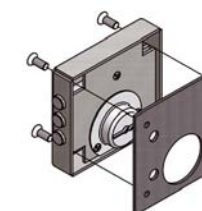
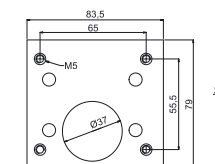

2800 GC - PER CASSAFORTI 6/8 LEVE

- Serratura laterale con 2 catenacci Ø 16 mm

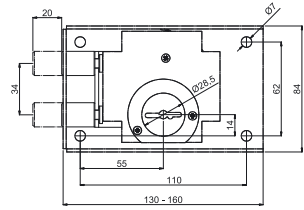

ART.	Gorges	Chiusure	Corsa	Dimensioni mm	Finitura
2800SROXXGBC2	6	1	20	130x84x26	RO
2800TROXXGBC2	6	1	20	160x84x26	RO

2810/30 XX - PER CASSAFORTI 6/8 LEVE

- Serratura laterale con 2 catenacci girevoli Ø 22 mm

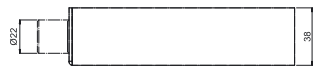
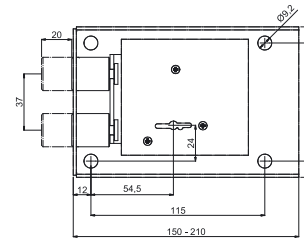

ART.	Gorges	Chiusure	Corsa	Dimensioni mm	Finitura
2810SROXXXXF82	8	1	20	150x100x38	RO
2830SROXXXXF82	8	1	20	210x100x38	RO

2822S XX - PER CASSAFORTI 6/8 LEVE

- Serratura laterale con 2 catenacci girevoli Ø 22 mm e combinatore

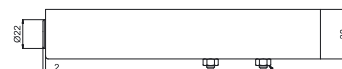
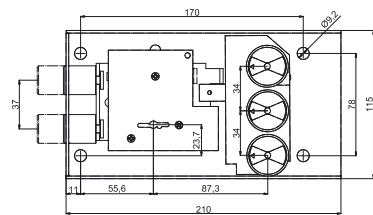

ART.	Gorges	Chiusure	Corsa	Dimensioni mm	Finitura
2822SROXXXXF82	8	1	20	210x115x38	RO

2840S XX - PER CASSAFORTI 6/8 LEVE

- Serratura tripla con 4 catenacci girevoli Ø 22 mm

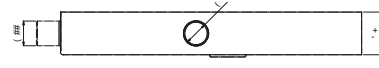
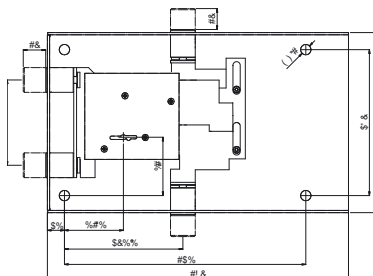

ART.	Gorges	Chiusure	Corsa	Dimensioni mm	Finitura
2840SROXXXXF82	8	3	20	270x160x38	RO

2842R XX - PER CASSAFORTI 6/8 LEVE

- Serratura tripla con 4 catenacci girevoli Ø 22 mm e combinatore

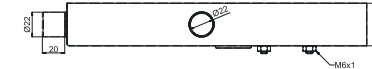
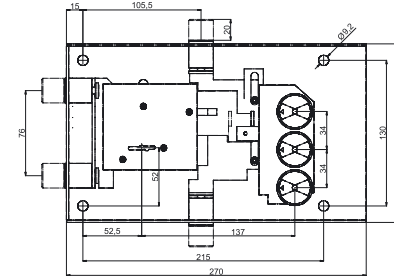

ART.	Gorges	Chiusure	Corsa	Dimensioni mm	Finitura
2842SROXXXXF82	8	3	20	270x160x38	RO

2850S XX - PER CASSAFORTI 6/8 LEVE

- Serratura tripla con 5 catenacci girevoli Ø 22 mm

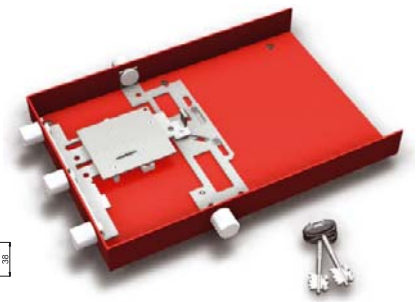
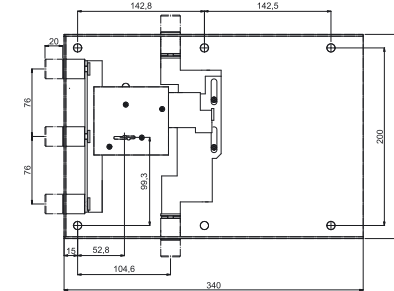

ART.	Gorges	Chiusure	Corsa	Dimensioni mm	Finitura
2850SROXXXXF82	8	3	20	340x230x38	RO

2852S XX - PER CASSAFORTI 6/8 LEVE

- Serratura tripla con 5 catenacci girevoli Ø 22 mm e combinatore

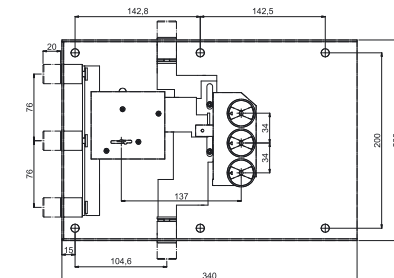

ART.	Gorges	Chiusure	Corsa	Dimensioni mm	Finitura
2852SROXXXXF82	8	3	20	340x230x38	RO

2860S XX - PER CASSAFORTI 6/8 LEVE

- Serratura tripla con 7 catenacci girevoli Ø 22 mm

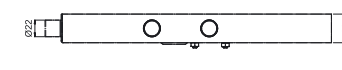
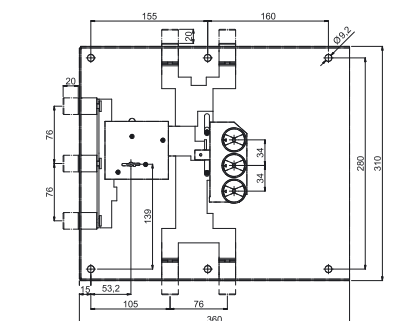

ART.	Gorges	Chiusure	Corsa	Dimensioni mm	Finitura
2860SROXXXXF82	8	3	20	360x310x38	RO

2862S XX - PER CASSAFORTI 6/8 LEVE

- Serratura triplice con 7 catenacci girevoli Ø 22 mm e combinatore

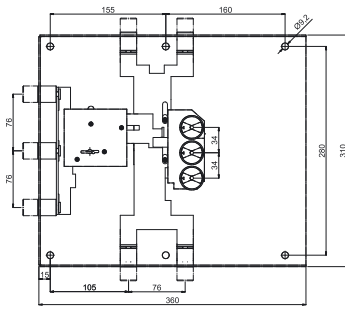

ART.	Gorges	Chiusure	Corsa	Dimensioni mm	Finitura
2862SROXXXXF82	8	3	20	360x310x38	RO

2870S XX - PER CASSAFORTI 6/8 LEVE

- Serratura triplice con 7 catenacci girevoli Ø 22 mm

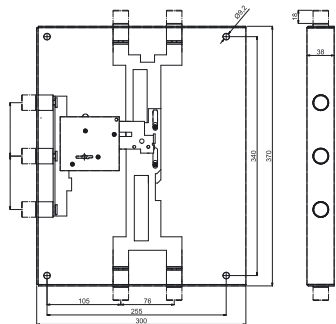

ART.	Gorges	Chiusure	Corsa	Dimensioni mm	Finitura
2872SROXXXXF82	8	3	20	300x370x38	RO

2872S XX - PER CASSAFORTI 6/8 LEVE

- Serratura triplice con 7 catenacci girevoli Ø 22 mm e combinatore

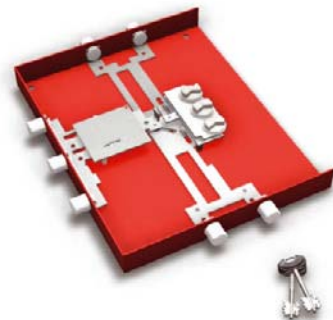
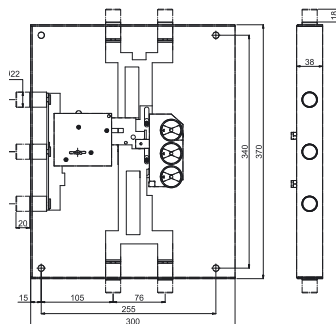

ART.	Gorges	Chiusure	Corsa	Dimensioni mm	Finitura
2872SROXXXXF82	8	3	20	300x370x38	RO

2872S XX - PER CASSAFORTI 6/8 LEVE

- Serratura triplice con 7 catenacci girevoli Ø 22 mm e combinatore

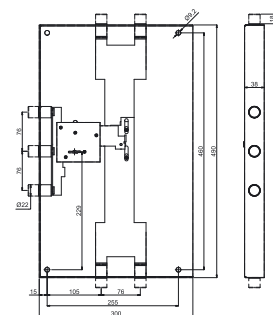

ART.	Gorges	Chiusure	Corsa	Dimensioni mm	Finitura
2880SROXXXXF82	8	3	20	300x490x38	RO

2815S XX - PER CASSAFORTI 6/8 LEVE

- Serratura laterale con 2 catenacci girevoli Ø 22 mm

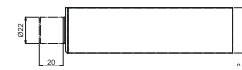
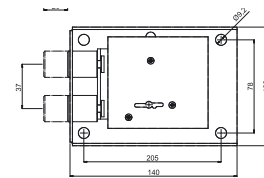

ART.	Gorges	Chiusure	Corsa	Dimensioni mm	Finitura
2815SGRXXXXF82	8	1	20	140x100x38	GR

2855S XX - PER CASSAFORTI 6/8 LEVE

- Serratura triplice con 5 catenacci girevoli Ø 22 mm

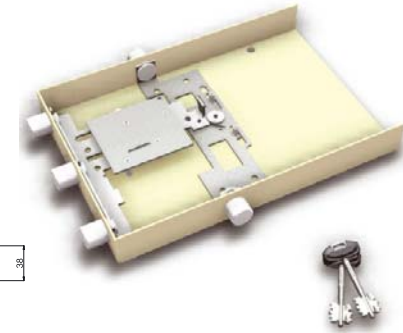
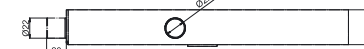
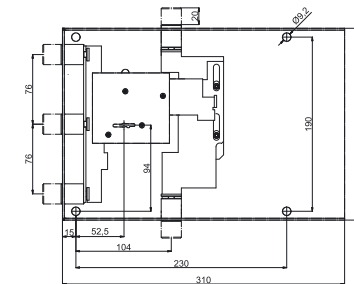

ART.	Gorges	Chiusure	Corsa	Dimensioni mm	Finitura
2855SGRXXXXF82	8	3	20	310x210x38	GR

2857S XX - PER CASSAFORTI 6/8 LEVE

- Serratura triplice con 5 catenacci girevoli Ø 22 mm e combinatore

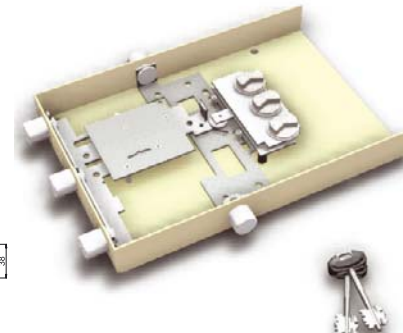
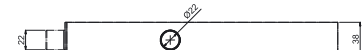
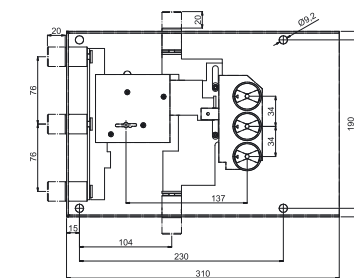

ART.	Gorges	Chiusure	Corsa	Dimensioni mm	Finitura
2857SGRXXXXF82	8	3	20	310x210x38	GR

2865S XX - PER CASSAFORTI 6/8 LEVE

- Serratura triplice con 5 catenacci girevoli Ø 22 mm

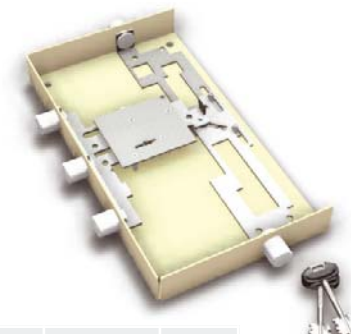
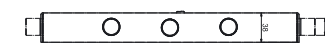
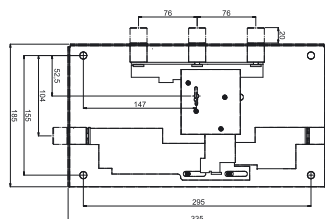

ART.	Gorges	Chiusure	Corsa	Dimensioni mm	Finitura
2865SGRXXXXF82	8	3	20	185x335x38	GR

2875S XX - PER CASSEFORTI 6/8 LEVE

- Serratura triplice con 5 catenacci girevoli Ø 22 mm e combinatore

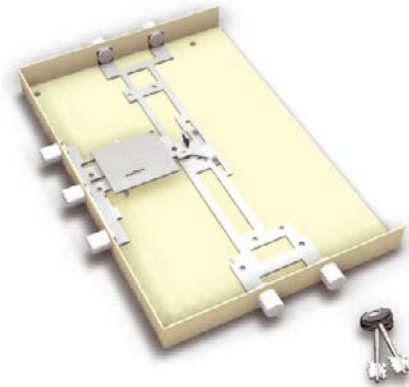
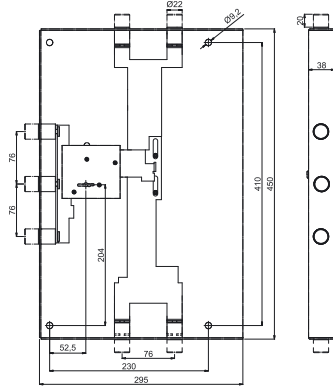

ART.	Gorges	Chiusure	Corsa	Dimensioni mm	Finitura
2875SGRXXXXF82	8	3	20	295x450x38	GR

2877S XX - PER CASSEFORTI 6/8 LEVE

- Serratura triplice con 7 catenacci girevoli Ø 22 mm e combinatore

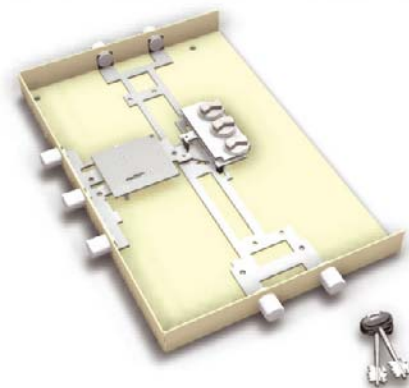
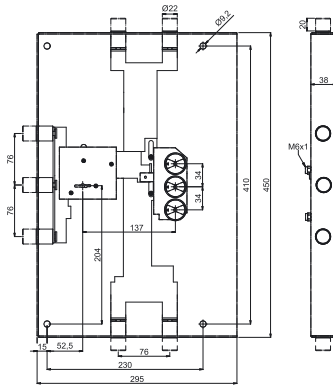

ART.	Gorges	Chiusure	Corsa	Dimensioni mm	Finitura
2877SGRXXXXF82	8	3	20	295x450x38	GR

2312S

- Combinatore con 3 pomelli e 20 posizioni per pomello

ART.	Finitura
2312SZB03XX	ZB

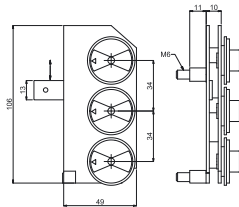

PS281

- Pistone catenaccio girevole Ø 22x30,5 mm per catenacci frontali

ART.	Finitura
PS2810XNI22XX	NK

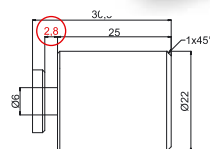

PS284

- Pistone catenaccio girevole Ø 22x29,7 mm per aste laterali

ART.	Finitura
PS2840XNI22XX	NK

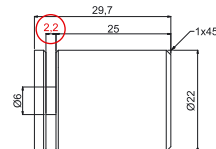

ACCESSORI

2975S PER CASSEFORTI ELETTRONICHE

- Serratura triplice con 7 catenacci girevoli Ø 22 mm
- Alimentazione 9 volt

DOTAZIONE

- Maniglia 5299XBK
- portapile PP2935XBKXXXX
- tastiera TA2935XBKXXXX

ART.	Finitura
5299XBK	BK

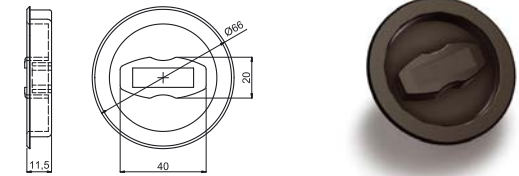

TA2935 PER CASSEFORTI ELETTRONICHE

- Tastiera per cassaforte elettronica

ART.	Finitura
TA2935XBKXXXX	GR

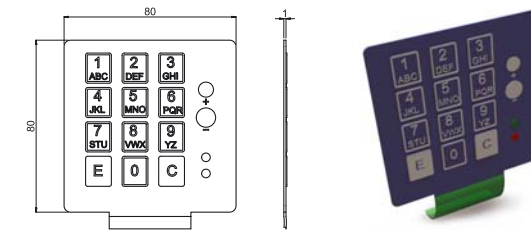

PP2935 PER CASSEFORTI ELETTRONICHE

- Porta pile per serratura elettronica

ART.	Finitura
PP2935XBKXXXX	BK

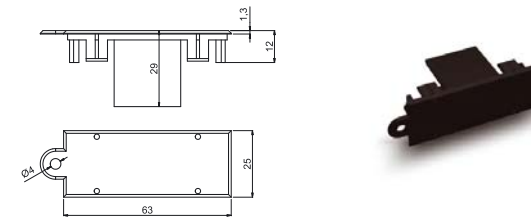

SERRATURE PER PORTE BLINDATE

SERIE 250 NUDA

Serratura nuda senza cuore per porte blindate serie 25. Predisposta per cuore sia a doppia mappa che a cilindro. Fissaggio laterale, planare e infilare. Chiusura triplice. Scrocco reversibile Ø 20 mm. azionato da chiave e quadro maniglia 8 mm. 4 catenacci Ø 18 mm con interasse 28 mm, 3 catenacci con interasse 37 mm.

Serrature da abbinare ai cuori a seguire.

2501 - FISSAGGIO PLANARE/LATERALE

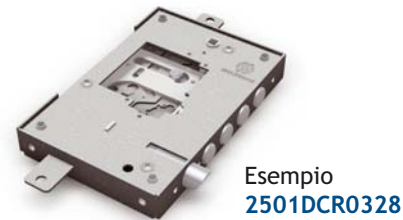
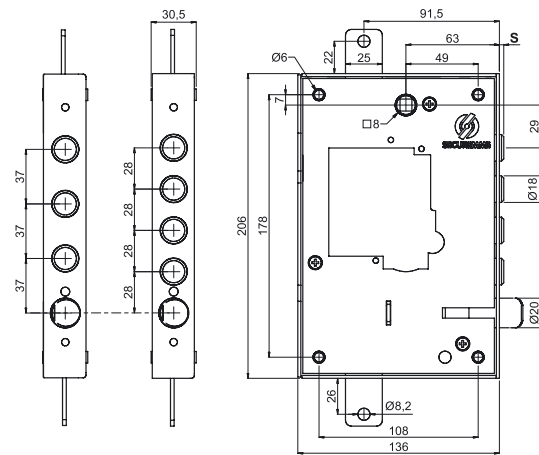

Mano destra (D) o spingere (R)	Mano sinistra (S) o tirare (L)	Sporgenza pistoncini (S)	Interasse
250 1 D CR0328	250 1 S CR0328	3 mm	28 mm
250 1 D CR0628	250 1 S CR0628	6 mm	28 mm
250 1 D CR1328	250 1 S CR1328	13 mm	28 mm
250 1 D CR4328	250 1 S CR4328	43 mm	28 mm

Mano destra (D) o spingere (R)	Mano sinistra (S) o tirare (L)	Sporgenza pistoncini (S)	Interasse
250 1 D CR0337	250 1 S CR0337	3 mm	37 mm
250 1 D CR0637	250 1 S CR0637	6 mm	37 mm
250 1 D CR1337	250 1 S CR1337	13 mm	37 mm
250 1 D CR4337	250 1 S CR4337	43 mm	37 mm

2501 - FISSAGGIO AD INFILARE

• Frontale INOX

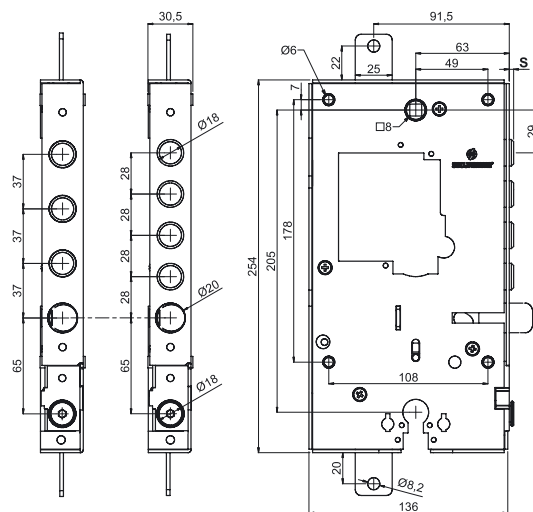

Mano destra (D) o spingere (R)	Mano sinistra (S) o tirare (L)	Sporgenza pistoncini (S)	Interasse
250 3 D CR0328	250 3 S CR0328	-	28 mm
250 3 D CR0337	250 3 S CR0337	-	37 mm

SERIE 254 NUDA

Serratura multifunzione nuda (senza cuore sulla serratura superiore) piu(cilindro con limitatore. Serratura superiore predisposta per cuore a doppia mappa o cilindro europeo. 4 catenacci Ø 18 mm con interasse 28 mm oppure 3 catenacci Ø 18 mm con interasse 37 mm. Serratura inferiore a cilindro europeo, 1 catenaccio Ø 18 mm 2 mandate corsa 20 mm che aziona sulla prima mandata il limitatore di apertura regolabile. Fissaggio laterale, planare e infilare. Chiusura triplice. Entrata chiave e maniglia 63 mm. Serratura destra, sinistra, spingere o tirare. Scrocco reversibile Ø 20 mm azionato da chiave e quadro maniglia 8 mm. A serratura chiusa la maniglia non sgancia lo scrocco. A RICHIESTA LA SERRATURA DI SERVIZIO BLOCCA LE ASTE DELLA SERRATURA SUPERIORE (ART. 2546 planare/laterale, 2548 infilare). Serrature da abbinare ai cuori a seguire. A richiesta versione con blocco aste.

2541 - FISSAGGIO PLANARE/LATERALE

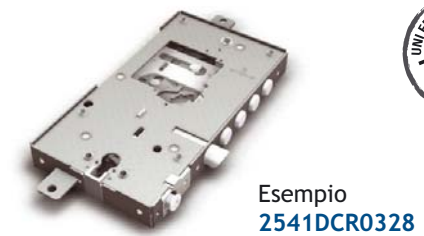
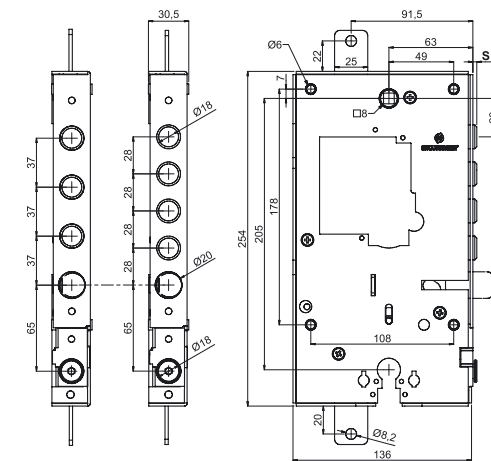

Mano destra (D) o spingere (R)	Mano sinistra (S) o tirare (L)	Sporgenza pistoncini (S)	Interasse
254 1 D CR0328	254 1 S CR0328	3 mm	28 mm
254 1 D CR0628	254 1 S CR0628	6 mm	28 mm
254 1 D CR1328	254 1 S CR1328	13 mm	28 mm
254 1 D CR4328	254 1 S CR4328	43 mm	28 mm

Mano destra (D) o spingere (R)	Mano sinistra (S) o tirare (L)	Sporgenza pistoncini (S)	Interasse
254 1 D CR0337	254 1 S CR0337	3 mm	37 mm
254 1 D CR0637	254 1 S CR0637	6 mm	37 mm
254 1 D CR1337	254 1 S CR1337	13 mm	37 mm
254 1 D CR4337	254 1 S CR4337	43 mm	37 mm

2501 - FISSAGGIO AD INFILARE

• Frontale INOX



Mano destra (D) o spingere (R)	Mano sinistra (S) o tirare (L)	Sporgenza pistoncini (S)	Interasse
254 3 D CR0328	254 3 S CR0328	-	28 mm
254 3 D CR0337	254 3 S CR0337	-	37 mm

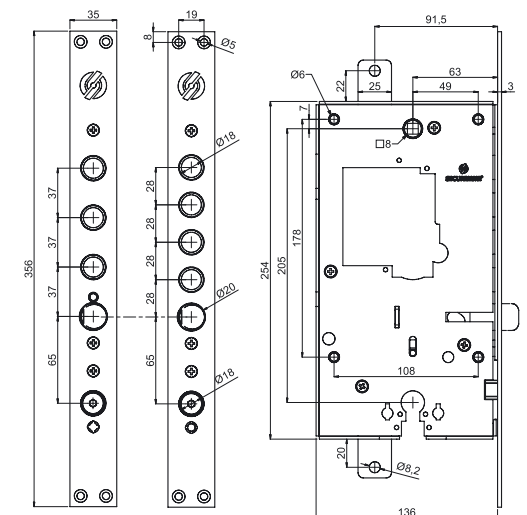

CUORI PER SERRATURE SERIE 250

25K

Cuore a doppia mappa a 4 mandate, corsa 40 mm, destro o sinistro con 1 chiave da cantiere KA unificata. Permette all'installatore di utilizzare 1 chiave per tutte le porte. A cantiere ultimato sostituire con un cuore definitivo.

Cuore	Mano destra	Mano sinistra	N. chiavi
25K CANTIERE	25KX D ZBXXXXK1	25KX S ZBXXXXK1	1

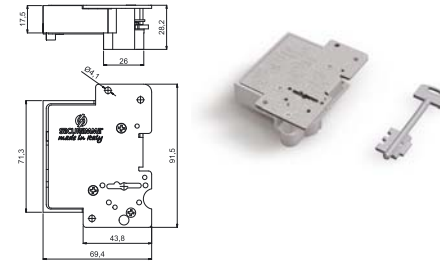

25M

Cuore EASY MASTER a doppia mappa, 4 mandate, corsa 40 mm, 6 leve, chiave gialla da cantiere che apre fino a un massimo di 5000 serrature, 3 chiavi definitive in confezione sigillata da abilitare a cantiere ultimato. Con l'abilitazione delle chiavi definitive la chiave da cantiere è inutilizzabile.

Cuore	Mano destra	Mano sinistra	N. chiavi
25M EASY MASTER	25MX D ZBXXXXM43	25MX S ZBXXXXM43	1 + 3



25S

Cuore definitivo a doppia mappa con brevetti contro la manipolazione e chiave protetta. 4 mandate corsa 40 mm, 6 leve.

Cuore	Mano destra	Mano sinistra	N. chiavi
25M EASY MASTER	25SX D ZBXXXXS46	25SX S ZBXXXXS46	3 + 1
	25SX D ZBXXXXS56	25SX S ZBXXXXS56	3 + 1
	25SX D ZBXXXXS66	25SX S ZBXXXXS66	3 + 1

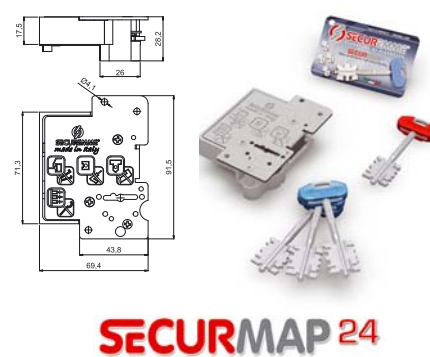

25C

Cuore a cilindro europeo, 4 mandate, corsa 40 mm.

Cuore	Mano destra	Mano sinistra	N. chiavi
25C CILINDRO	25CX D ZB	25CX S ZB	-

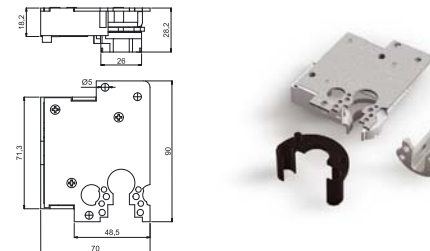

25C

Cuore a cilindro europeo Securtina. 4 mandate, corsa 40 mm. Blocco del cilindro in caso di estrazione forzata.

Cuore	Mano destra	Mano sinistra	N. chiavi
25T CILINDRO SECURTINA	25TX D ZB	25TX S ZB	-

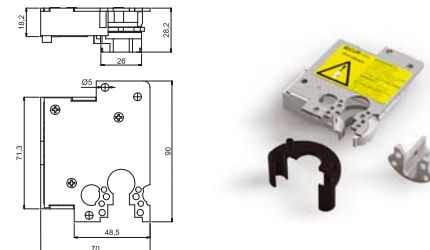

SERRATURE PER PORTE BLINDATE

SERIE 2514

Serratura triplice con cuore a doppia mappa. Il pomolo che aziona il catenaccio a 3 pistoni e lo scrocco. 2 mandate di blocco con chiave a doppia mappa Securmap 24 con possibilità di cambio cuore doppia mappa/cilindro. 4 chiavi gambo 50 mm predisposti per fissaggio dei protector. Pomolo frizionato a serratura chiusa con le mandate. Catenaccio di servizio indipendente azionato da cilindro (2 mandate). Serratura con scrocco reversibile destra/sinistra. Fissaggio planare e laterale.

2514 - CUORE A DOPPIA MAPPA

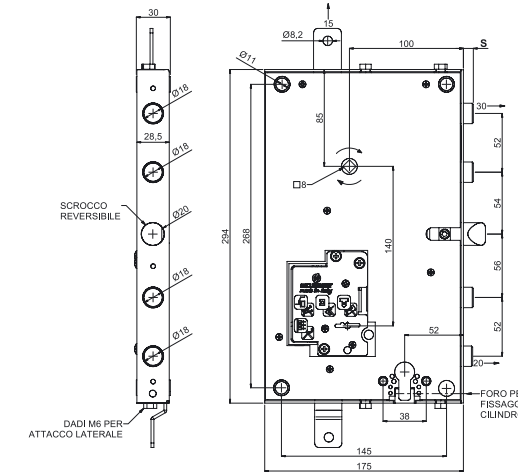

Esempio
2514UCR09XXS56

Esempio
2514UCR40XXS56

Art.	Mandate	Sporgenza pistoni (S)	Finitura
2514UCR09XXS56	2	9 mm	CR
2514UCR40XXS56	2	40 mm	CR
2514UCR70XXS56	2	70 mm	CR

SERIE 2614

Serratura triplice, con cuore a cilindro. Il pomolo aziona il catenaccio a 3 pistoni e lo scrocco. 2 mandate di blocco con chiave a cilindro predisposto per il fissaggio dei protector. Possibilità di cambio cuore cilindro/doppia mappa. Pomolo frizionato a serratura chiusa con le mandate. Catenaccio di servizio indipendente azionato da cilindro (2 mandate). Serratura con scrocco reversibile destra/sinistra.

2614 - CUORE A CILINDRO

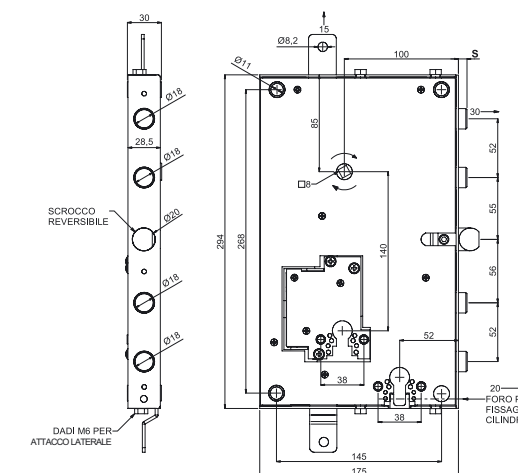

Esempio
2614UCR09XXCXX

Esempio
2614UCR40XXCXX

Art.	Mandate	Sporgenza pistoni (S)	Finitura
2614UCR09XXCXX	2	9 mm	CR
2614UCR40XXCXX	2	40 mm	CR
2614UCR70XXCXX	2	70 mm	CR

PIASTRINE

4913

- Piastrina interna/esterna per serie 2514 a doppia mappa e cilindro.

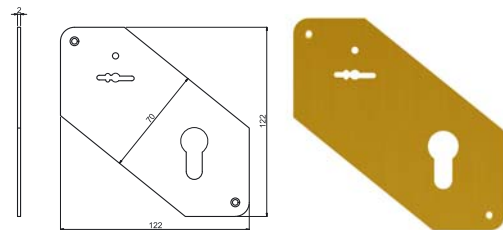

Art.	Finitura
4913KOS	OL
4913KAI	CS
4913KF4	F4

4914

- Piastrina esterna per serrature serie 2514 a doppia mappa e protector.

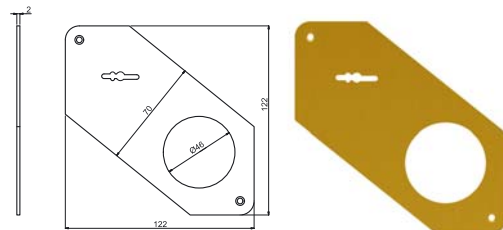

Art.	Finitura
4914KOS	OL
4914KAI	CS
4914KF4	F4

4915

- Piastrina interna/esterna per serie 2614 con doppio foro cilindro.

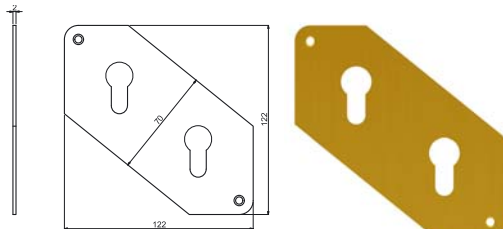

Art.	Finitura
4915KOS	OL
4915KAI	CS
4915KF4	F4

4916

- Piastrina esterna per serie 2614 con doppio protector.

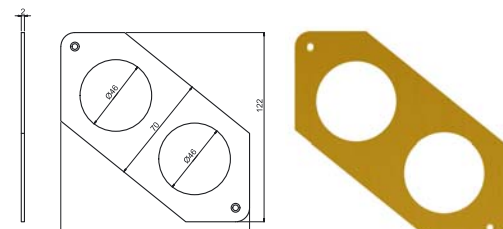

Art.	Finitura
4916KOS	OL
4916KAI	CS
4916KF4	F4

4917

- Piastrina esterna per serie 2614 con protector e cilindro.

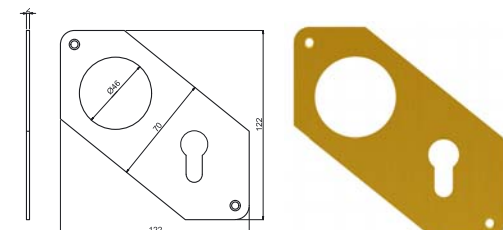

Art.	Finitura
4917KOS	OL
4917KAI	CS
4917KF4	F4

DISPOSITIVO PER AUTOMAZIONE SERRATURA - D-SMART

8000X

Dispositivo di automazione serratura a batteria, applicabile a tutte le serrature a cilindro europeo con codolo Ø 8 mm. Dimensione placca 230x65x25 mm. Semplicità di installazione. Apertura tramite Smartphone e contatto pulito (es. citofono, pulsante o sistema domotico).

Il kit include: batteria ricaricabile, caricabatteria, magneti, maniglia e pomolo. Gestione e programmazione da smartphone tramite tecnologia sicura e criptata **Bluetooth**. Chiusura automatica della porta.

Art.	Finitura
8000XF1	Argento
8000XF4	Bronzo



8001X

Dispositivo di automazione serratura a batteria. Versione come articolo 8002 ma senza transponder.

Art.	Finitura
8001XF1	Argento
8001XF4	Bronzo



8002X

Dispositivo di automazione serratura a batteria, applicabile a tutte le serrature a cilindro europeo con codolo Ø 8 mm. Dimensione placca 230x65x25 mm. Semplicità di installazione. Apertura tramite Smartphone, tastiera numerica, transponder e contatto pulito (es. citofono, pulsante o sistema domotico).

Il kit include: batteria ricaricabile, caricabatteria, tastiera numerica, 1 transponder, magneti, maniglia e pomolo. Gestione e programmazione da smartphone tramite tecnologia sicura e criptata **Bluetooth**.

Chiusura automatica della porta. Opzione Guest key disponibile.

Art.	Finitura
8000XF1	Argento
8000XF4	Bronzo



8010X

Dispositivo di automazione serratura alimentato, applicabile a tutte le serrature a cilindro europeo con codolo Ø 8 mm. Dimensione placca metallica 187x65x8 mm. Semplicità di installazione. Apertura tramite Smartphone e contatto pulito (es. citofono, pulsante o sistema domotico). Il kit include: Trasformatore, passacavo, cavo di collegamento, magnete, maniglia e pomolo. Gestione e programmazione da smartphone tramite tecnologia sicura e criptata **Bluetooth**. Chiusura automatica della porta.



Art.	Finitura
8010XF14580	Argento
8010XF44580	Bronzo



8011X

Dispositivo di automazione serratura alimentato. Versione come articolo 8012XF14580/ 8012XF44580 ma senza transponder.



Art.	Finitura
8011XF14580	Argento
8011XF44580	Bronzo



8010X

Dispositivo di automazione serratura alimentato, applicabile a tutte le serrature a cilindro europeo con codolo Ø 8 mm. Dimensione placca metallica 187x65x8 mm. Semplicità di installazione. Apertura tramite Smartphone, tastiera numerica, transponder e contatto pulito (es. citofono, pulsante o sistema domotico). Il kit include: Trasformatore, passacavo, cavo di collegamento, tastiera numerica, 1 transponder, magnete, maniglia e pomolo. Gestione e programmazione da smartphone tramite tecnologia sicura e criptata **Bluetooth**. Chiusura automatica della porta. Opzione Guest key disponibile.



Art.	Finitura
8012XF14580	Argento
8012XF44580	Bronzo



ACCESSORI E RICAMBI D-SMART

PP8000K

- Batteria al litio 3700 mAh D-SMART



Art.	Finitura
PP8000KF1XXBT	Argento
PP8000KF4XXBT	Bronzo

CB8000X

- Caricabatteria D-SMART



Art.	Finitura
CB8000XBKXXX	Nero

TA8001

- Tastiera elettronica con lettore transponder

Art.	Finitura
TA8001KBK4307	Nero



4307X

- Piastrina per tastiera esterna 62x82 mm

Art.	Finitura
4307XF1	F1
4307XF3	F3
4307XF4	F4
4307XOL	OL
4307XCL	CL
4307XCS	CS

CT8001

- Cavo cablaggio D-SMART a tastiera esterna lunghezza 60 cm



ART.
CT8001XXXXXTA

CT8010

- Cavo alimentazione esterna 4 fili lunghezza 3 m



ART.
CT8010XXX04QE

OC27

- Transponder in aggiunta alla dotazione



ART.
OC27XXXKEYF

PV2700

- Passacavo



ART.
PV2700XZBXXXX

SH8010

- Trasformatore 100 - 240 V AC per D-SMART alimentata



ART.
SH8010XXXXXQE

MG8000

- Magnete adesivo Ø 20 x 2 mm



ART.
MG8000XXXXXPO

CILINDRI

SERIE 36 EVOK64

Cilindro di altissima sicurezza con doppio sistema di cifratura meccanico a 11 perni e pista a 4 elementi mobili attivi. Chiave protetta da Marchio Comunitario Figurativo n° 015336886® e da Design Comunitario Registrato N° 003030386-0001/0002 per un'elevata tutela contro la riproduzione illegale della chiave. **Duplicazione chiave controllata.** La riproduzione puo avvenire unicamente previa esibizione della security card e di una chiave originale. Security card per la duplicazione autorizzata delle chiavi presso TEAM SECUREMME.

- Numero di combinazioni > di 4,5 milioni
- Doppio sistema anti-bump con PIN UNICO e pista
- Anti-spezzamento con rottura controllata
- Anti-estrazione del rotore con spine quadre in acciaio temprato - Anti-pick
- Anti-trapano
- Cam din 30° per un'elevata resistenza alla spinta
- Finiture: cromo
- Esecuzioni speciali KA - CA - TANDEM abbinato a EvoK22



SISTEMA CAMBIO CIFRATURA: il cilindro funziona sia con la chiave "C" (inserto rosso) che con le chiavi sigillate. Per disattivare la chiave "C" inserire la chiave metallica "X" e fare un giro completo di 360° quindi estrarla. L'operazione e irreversibile quindi la chiave "C" disattivata non si puo piu usare e si consiglia la distruzione.



PERSONALIZZA IL TUO CILINDRO

Personalizza i tuoi cilindri, richiedendo il tuo logo sull'inserto della chiave. L'inserto e disponibile in vari colori. Forma ergonomica della chiave e inserto removibile. Design e sistema brevettato.

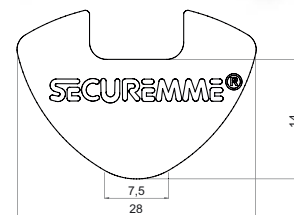

- Arancio
- Rosso
- Verde
- Blu
- Grigio
- Azzurro

SERIE 36 - CHIAVE-CHIAVE DOPPIA FUNZIONE

- DISPONIBILE IN TUTTE LE MISURE FINO A MAX 200 (125-75 mm)
- Su richiesta possibilita esecuzione KA (chiavi uguali).

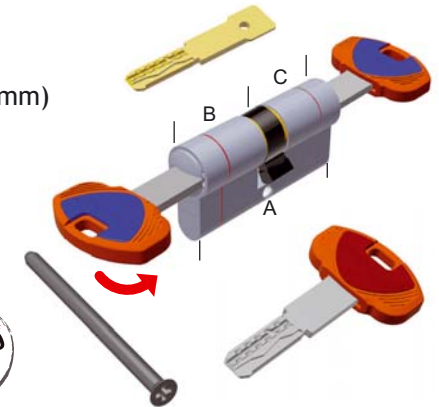
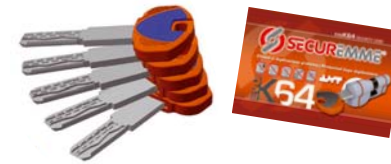

* Campo da riempire, inserendo le lettere che identificano il profilo chiave assegnato. Esempio profilo 1A = 361AMCS2510113

Art.	Finitura	A	B	C
36_*-D	36_*_DCS3030115	62	31	31
36_*-D	36_*_DCS3035115	67	31	36
36_*-D	36_*_DCS3040115	72	31	41
36_*-D	36_*_DCS3045115	77	31	46
36_*-D	36_*_DCS3050115	82	31	51
36_*-D	36_*_DCS3055115	87	31	56
36_*-D	36_*_DCS3060115	92	31	61
36_*-D	36_*_DCS3065115	97	31	66
36_*-D	36_*_DCS3070115	102	31	71
36_*-D	36_*_DCS3080115	112	31	81
36_*-D	36_*_DCS3085115	117	31	86
36_*-D	36_*_DCS3090115	122	31	91
36_*-D	36_*_DCS3535115	72	36	36
36_*-D	36_*_DCS3540115	77	36	41
36_*-D	36_*_DCS3545115	82	36	46
36_*-D	36_*_DCS3550115	87	36	51
36_*-D	36_*_DCS3555115	92	36	56
36_*-D	36_*_DCS3560115	97	36	61
36_*-D	36_*_DCS3565115	102	36	66
36_*-D	36_*_DCS3570115	107	36	71
36_*-D	36_*_DCS4040115	82	41	41
36_*-D	36_*_DCS4045115	87	41	46
36_*-D	36_*_DCS4050115	92	41	51
36_*-D	36_*_DCS4055115	97	41	56
36_*-D	36_*_DCS4060115	102	41	61

Art.	Finitura	A	B	C
36_*-D	36_*_DCS4065115	107	41	66
36_*-D	36_*_DCS4070115	112	41	71
36_*-D	36_*_DCS4080115	122	41	81
36_*-D	36_*_DCS4545115	92	46	46
36_*-D	36_*_DCS4550115	97	46	51
36_*-D	36_*_DCS4555115	102	46	56
36_*-D	36_*_DCS4560115	107	46	61
36_*-D	36_*_DCS4565115	112	46	66
36_*-D	36_*_DCS4570115	117	46	71
36_*-D	36_*_DCS5050115	102	51	51
36_*-D	36_*_DCS5055115	107	51	56
36_*-D	36_*_DCS5060115	112	51	61
36_*-D	36_*_DCS5065115	117	51	66
36_*-D	36_*_DCS5070115	122	51	71
36_*-D	36_*_DCS5555115	112	56	56
36_*-D	36_*_DCS5560115	117	56	61
36_*-D	36_*_DCS5565115	122	56	66
36_*-D	36_*_DCS5570115	117	56	61
36_*-D	36_*_DCS6060115	122	61	61
36_*-D	36_*_DCS6065115	127	61	66
36_*-D	36_*_DCS6070115	132	61	71
36_*-D	36_*_DCS6565115	132	66	66
36_*-D	36_*_DCS6570115	137	66	71
36_*-D	36_*_DCS7070115	142	71	71

SERIE 36 - PREDISPOSIZIONE POMOLO

Art.	Finitura	A	B	C
36_*-Q	36_*_QCS3030115	62	31	31
36_*-Q	36_*_QCS3035115	67	31	36
36_*-Q	36_*_QCS3040115	72	31	41
36_*-Q	36_*_QCS3045115	77	31	46
36_*-Q	36_*_QCS3050115	82	31	51
36_*-Q	36_*_QCS3055115	87	31	56
36_*-Q	36_*_QCS3060115	92	31	61
36_*-Q	36_*_QCS3065115	97	31	66
36_*-Q	36_*_QCS3070115	102	31	71
36_*-Q	36_*_QCS3080115	112	31	81
36_*-Q	36_*_QCS3085115	117	31	86
36_*-Q	36_*_QCS3090115	122	31	91

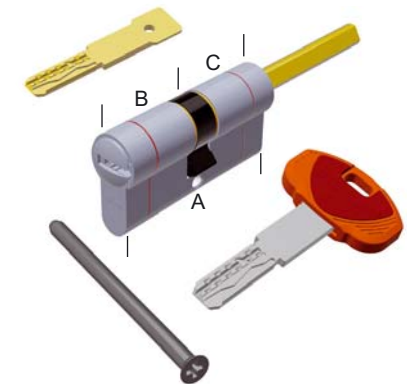

Dotazione come sopra ma con pomolo

PROTECTOR E COORDINATI

4255 - TOPSICUR-SCUDO

- Protector Topsicur Ø 55 mm in acciaio carbonitrurato.
- Durezza > 60 HRC resistente al trapano.
- Guidachiave in acciaio carbonitrurato.
- Base in ottone
- Rosetta con viti a scomparsa



ESTERNO



INTERNO



Art.	Interasse	Finitura
4255KOB14M2	38	OB
4255KOL14M2	38	OL
4255KCL14M2	38	CL
4255KCS14M2	38	CS

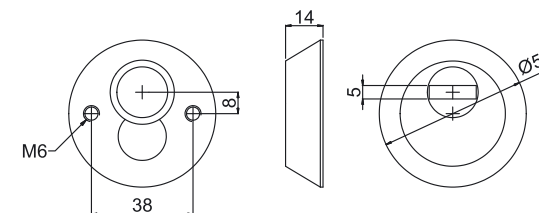

4265 - TOPSICUR-SCUDO

- Protector Topsicur Ø 65 mm in acciaio carbonitrurato.
- Durezza > 60 HRC resistente al trapano.
- Guidachiave in acciaio carbonitrurato.
- Base in ottone



ESTERNO



INTERNO



Art.	Interasse	Finitura
4265KOB14M2	-	OB
4265KOL14M2	-	OL
4265KCS14M2	-	CS

